

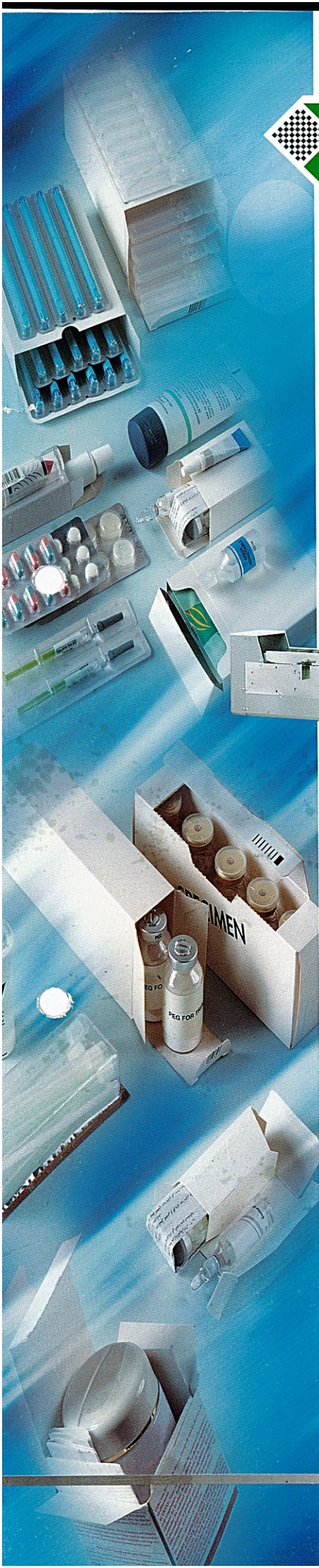

Promatic

P100-P150

ASTUCCIATRICE
ALTERNATA ORIZZONTALE



- ◆ Atta al confezionamento di prodotti farmaceutici e cosmetici
- ◆ Utilizza un sistema di apertura "positiva" degli astucci
- ◆ Predisposta e flessibile alle personalizzazioni
- ◆ Dispone di alimentazioni prodotto affidabili ed efficienti
- ◆ Strutturata a balcone e conforme alla normativa GMP
- ◆ Ergonomica
- ◆ Dotata di magazzino astucci e prospetti di elevata capacità
- ◆ Gestita a mezzo PLC
- ◆ Completa di pannello operatore tipo "touch-screen"

 **romaco**

P100-P150

ASTUCCIATRICE
ALTERNATA ORIZZONTALE

Flaconi

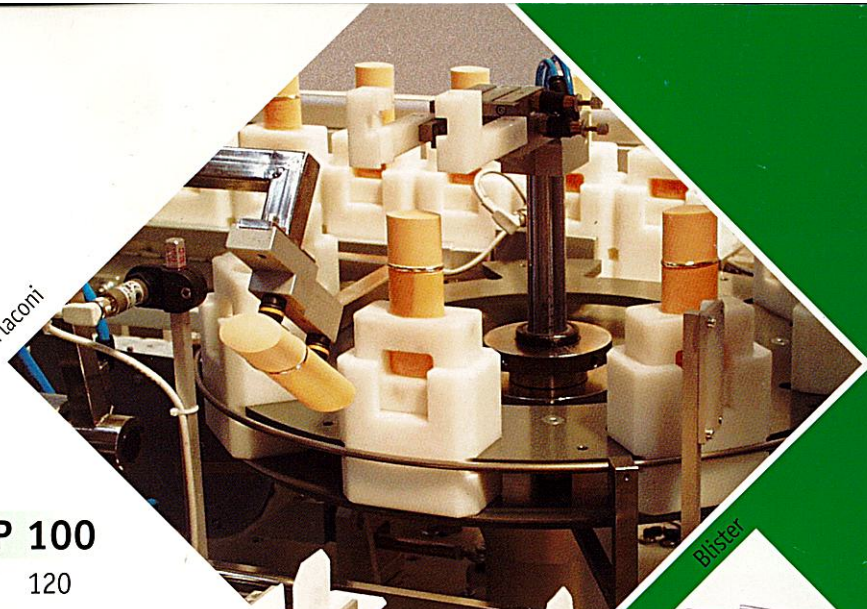

Blister

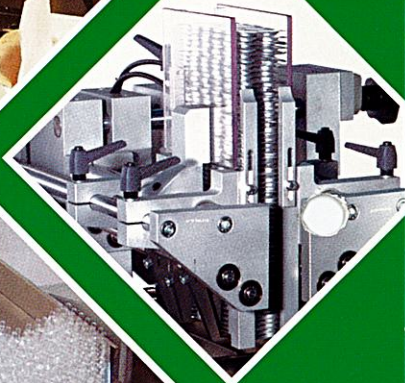

Dati tecnici

P 150 **P 100**

Velocità meccanica max (cicli/min)	150	120
Produzione max (astucci/min)	120	100
Potenza assorbita (kW)	3,5	3,5
Consumo aria compressa (NL/1')	70	70
Pressione aria di (bar)	6	6
Peso circa (Kg)	1800	1800

Gamma formati

P 150 **P 100**

(mm)	Min.	Max.	Min.	Max.
A	20	100	20	125
B	15	85	15	85
C	60	150	60	210
A+B	185		210	

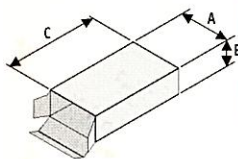

Flaconcini / Fiale



Tubetti schiacciabili

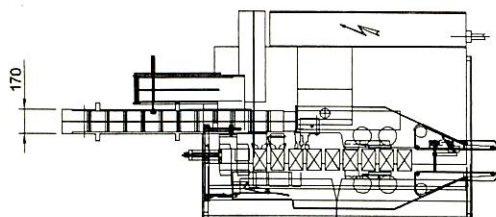
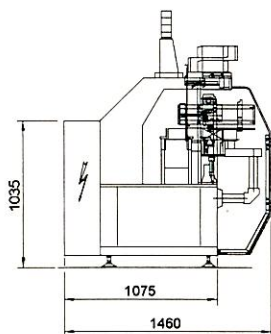
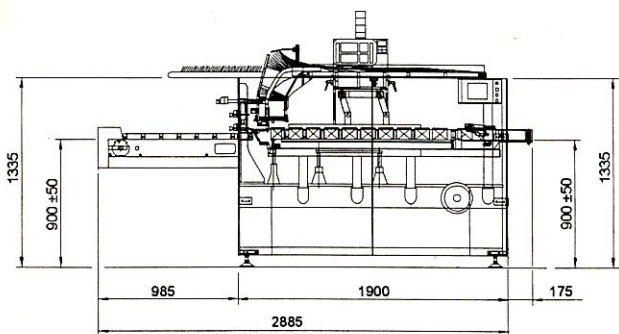
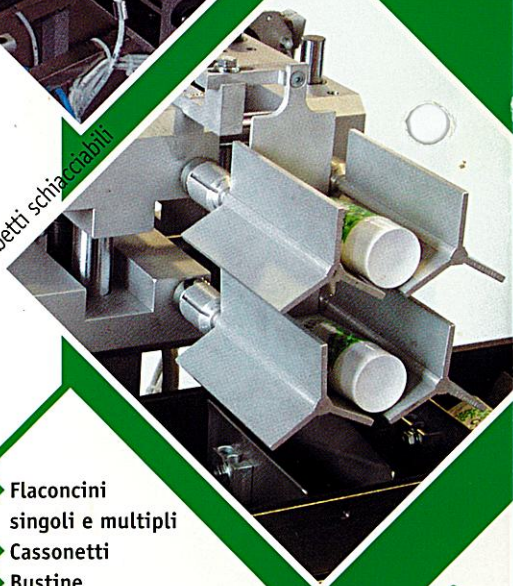

- ◆ Flaconcini singoli e multipli
- ◆ Cassonetti
- ◆ Bustine
- ◆ Vasetti
- ◆ Tubi rigidi per pastiglie
- ◆ Rossetti
- ◆ Prodotti con canettato e libretti
- ◆ Prodotti particolari



Promatic division of Romaco S.p.A. - info.promatic@romaco.com
Tel. +39/051.74.48.17 - Fax +39/051.74.31.92 - ITALIA

www.romaco.com